

FICHA TÉCNICA PANEL DE CERRAMIENTO

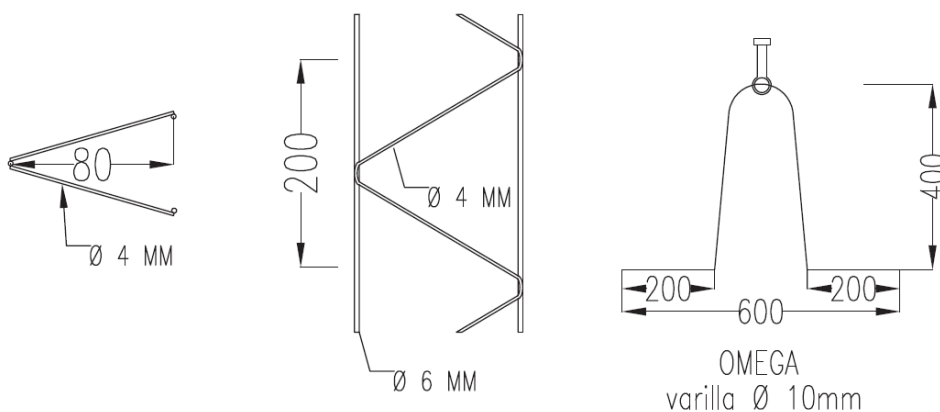
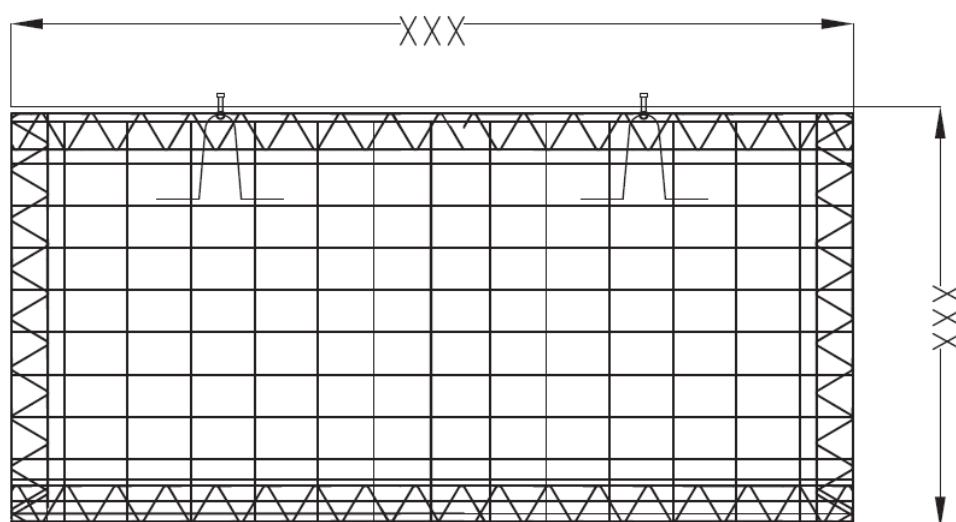

Estos datos técnicos son para paneles de espesor 14 cm; otros espesores consultar

CARACTERÍSTICAS TÉCNICAS	
Espesor	14 Cm
Peso	350 Kg/m²
Resistencia al Fuego	EI-120
Aislamiento Acústico	R_A = 54,36 dBA
Aislamiento Térmico	K = 3,73 W/m²°C
Hormigón	HA-30
Acero	B500T